

# TEP421 SPECIFICATIONS

## pure:2 electronica deck-mounted bath mixer with handshower

### FEATURES:

- Four-hole deck-mounted electronic control bath mixer with round wand handshower & flexible hose
- 9¾" spout with customized laminar flow
- Touch control allows for easy on/off, with LED-light ring indicator as a visual temperature indicator
- Three individualized presets that allow for quick access to desired temperatures
- Durable, polished chrome finish and sleek design
- Duration of water flow can be set to specific volumes, allowing for automatic shut-off once tub is full
- Meets low lead drinking water standards
- Cleaning mode allows you to temporarily switch off electronic components for easy & safe cleaning
- Temperature limit can be set, providing scald protection
- Thermal disinfection valve facilitates internal flush process to remove stagnant water build-up
- Requires electronica bathtub & shower control mixer TEE030 (see attached)



### SPECIFICATIONS:

Recommended: 14.5-72.5 psi (1-5 bar)

#### Water Supply:

Operating pressure max: 145 psi (10 bar)

Test Pressure: 232 psi (16 bar)

Difference of input pressure: < 14.5 psi (1 bar)

Flowrate: handshower 2.0 gpm @ 80 psi  
spout TBC

#### Connections:

Inlet: 2x ½" female thread

Outlet: 2x ½" female thread

#### Temperatures:

Operating environment: 4-40°C / 40-140°F

Humidity: max. 95% (non-condensing)

#### Electricity:

Line voltage: 100-240V AC / 50~60 Hz

Frequency: 50/60Hz

Power: stand by: <1W

max: <45W

#### Warranty:

Limited lifetime tapware warranty (residential)

Five year electronic part warranty (residential)

One year warranty (commercial)

Material:

Brass body

Finish:

Polished chrome

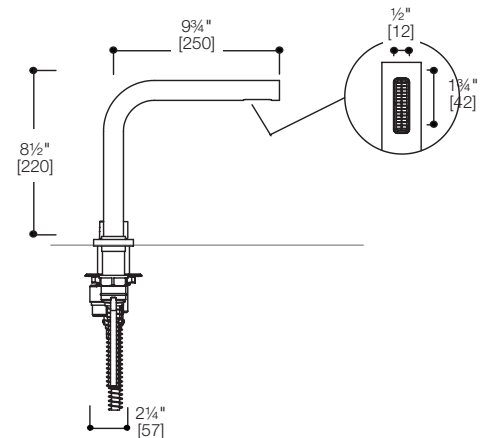
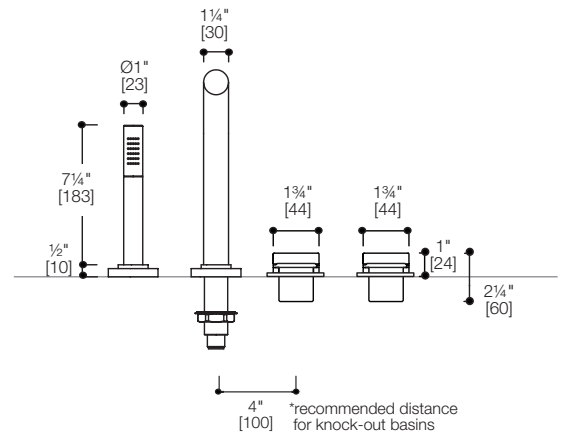

### FOR PURCHASE SEPARATELY:



\*Required control mixer TEE030 (specs attached)

\*Approximate measurements for comparison only.  
Note: These dimensions and specifications are subject to change without notice.

# TEP421 SPECIFICATIONS

## pure:2 electronica deck-mounted bath mixer with handshower

### INSTALLATION

Our products must be installed by certified professionals only and according to our installation guide as well as federal, provincial/state and local building codes and regulations. Installation must allow for future access to control box for maintenance purposes. This work must be carried out in accordance with the regulations IEC 364-7-701-1984 (corresponding to VDE 0100 Part 701) as well as all national local regulations.

Any electrical installation work must only be performed by a qualified electrician.

### SAFETY NOTES:

- Prevent danger resulting from damaged power supply cables. In the case of damage, the power supply cable must be replaced by the manufacturer or his customer service department or an equally qualified person.
- Installation is only possible in frost-free rooms. The optional power supply unit is only suitable for indoor use.
- The plug-in connectors must not be directly or indirectly sprayed with water when cleaning.
- The voltage supply must be separately switchable.
- The maximum permissible distance between the electronic controller and the functional unit is 19.6 feet (6m).
- If the static pressure exceeds (72.5 psi), a pressure reducing valve must be fitted.

### CODES / STANDARDS APPLICABLE:

- Meets or exceeds ANSI / ASME standard A112.18.1 and CAN / CSA B125.1-05 requirements
- IAPMO/ UPC / cUPC
- Calgreen compliant

### QUICK-REF WALL-MOUNT INSTALLATION:

- interface power
- mixer
- hot water
- cold water

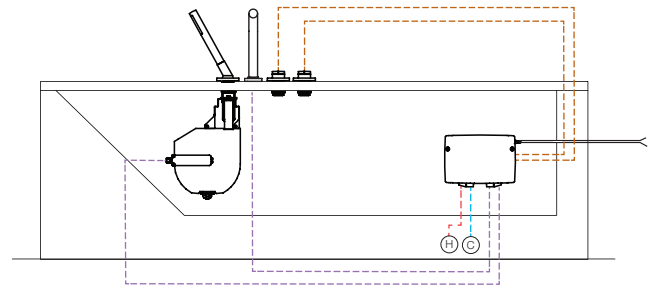

### NOTE:

Power cable must not be left exposed. Please refer to the installation guide.



AB1953 Compliant

CALGreen

\*Approximate measurements for comparison only.  
Note: These dimensions and specifications are subject to change without notice.

# TEE030 SPECIFICATIONS

## electronica thermostatic control mixer for shower & bathtub

### FEATURES:

- Thermostatic control mixer for shower & bathtub installation
- Easy installation, template provided and only two screws required
- Internal back-up rechargeable battery included, providing continuous usage during temporary power outages
- Fail-safe design with multiple back-up microprocessors
- Includes ceramic valves with redundant shut-offs for leak protection
- Flow sensor allows user to preset the preferred flow level, ensuring automatic shut-off once tub has been filled
- Quick-connect adaptors provide easy rough plumbing installation & removal

### SPECIFICATIONS:

Recommended: 14.5-72.5 psi (1-5 bar)

#### Water Supply:

Operating pressure max: 145 psi (10 bar)

Test Pressure: 232 psi (16 bar)

Difference of input pressure: < 14.5 psi (1 bar)

Flowrate: 9.6 gpm @ 50 psi

#### Connections:

Inlet: 2x 1/2" female thread

Outlet: 2x 1/2" female thread

#### Temperatures:

Operating environment: 4-40°C / 40-140°F

Humidity: max. 95% (non-condensing)

#### Electricity:

Line voltage: 100-240V AC / 50~60 Hz

Frequency: 50/60Hz

Power: stand by: <1W

max: <45W

#### Warranty:

Five year electronic part warranty (residential)  
(batteries not included)

One year warranty (commercial)

### INSTALLATION:

Control mixer is to be installed behind the wall, plugged into a direct power source. Installation must allow for future access to control box for maintenance purposes. This work must be carried out in accordance with the regulations IEC 364-7-701-1984 (corresponding to VDE 0100 Part 701) as well as all national local regulations. Any electrical installation work must only be performed by a qualified electrician.

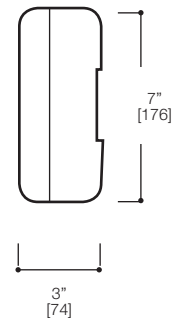
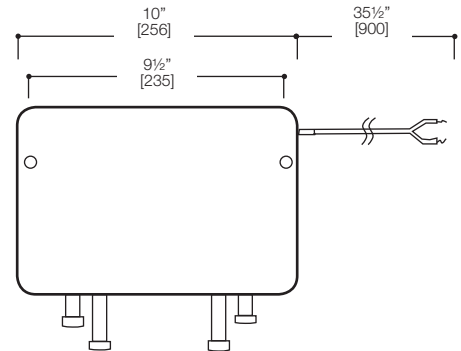
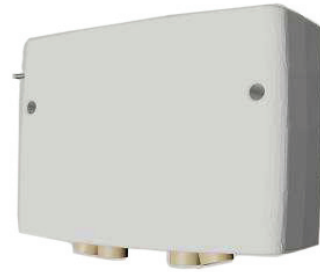

\*Approximate measurements for comparison only.  
Note: These dimensions and specifications are subject to change without notice.

# TEE030 SPECIFICATIONS

electronica thermostatic control mixer for shower & bathtub installation

## SAFETY NOTES:

- Prevent danger resulting from damaged power supply cables. In the case of damage, the power supply cable must be replaced by a qualified person.
- Two-prong plug must be hardwired into a standard direct power source.
- Installation is only possible in frost-free rooms. The optional power supply unit is only suitable for indoor use. This product is not waterproof, however, the design incorporates a channel to allow for removal of condensation.
- The plug-in connectors must not be directly or indirectly sprayed with water when cleaning.
- The voltage supply must be separately switchable.
- The maximum permissible distance between the electronic controller and the functional unit is 19.6 feet (6m) (234").
- If the static pressure exceeds (72.5 psi), a pressure reducing valve must be fitted.
- Installer must ensure the control mixer is positioned in the correct manner according to installation guide.

## APPROVAL & CONFORMITY:

This device complies with part 15 of the FCC Rules (USA) and with the RSS of the IC Rules (Canada).

Operation is subject to the following two conditions:

This device may not cause harmful interference, and this device must accept any interference received, including interference that may cause undesired operation. Changes or modifications not expressly approved by the party responsible for compliance may void the user's authority to operate the equipment.

## CODES / STANDARDS APPLICABLE:

- Meets or exceeds ANSI / ASME standard A112.18.1 and CAN / CSA B125.1-05 requirements
- IAPMO/ UPC / cUPC

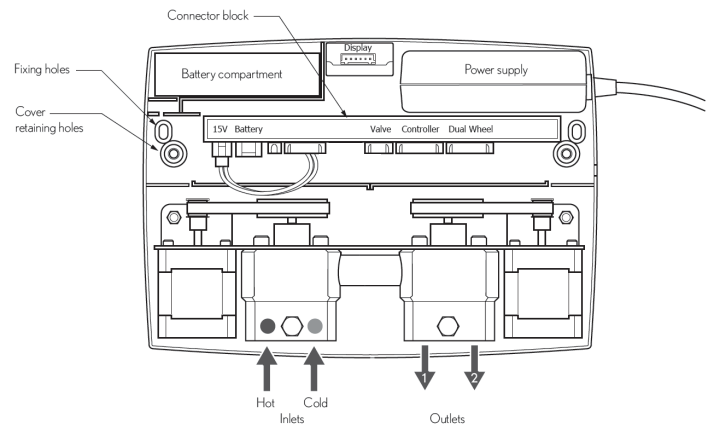
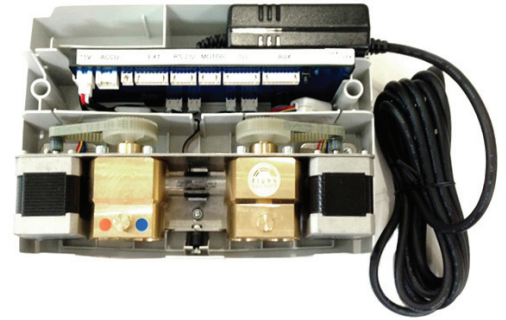

\*Approximate measurements for comparison only.  
Note: These dimensions and specifications are subject to change without notice.